

# OUTLINE DIMENSIONS

MODEL EV2130

UNIT mm

**EIZO Corporation**

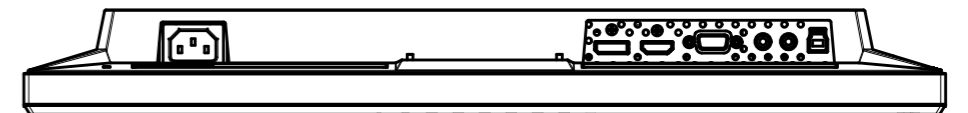
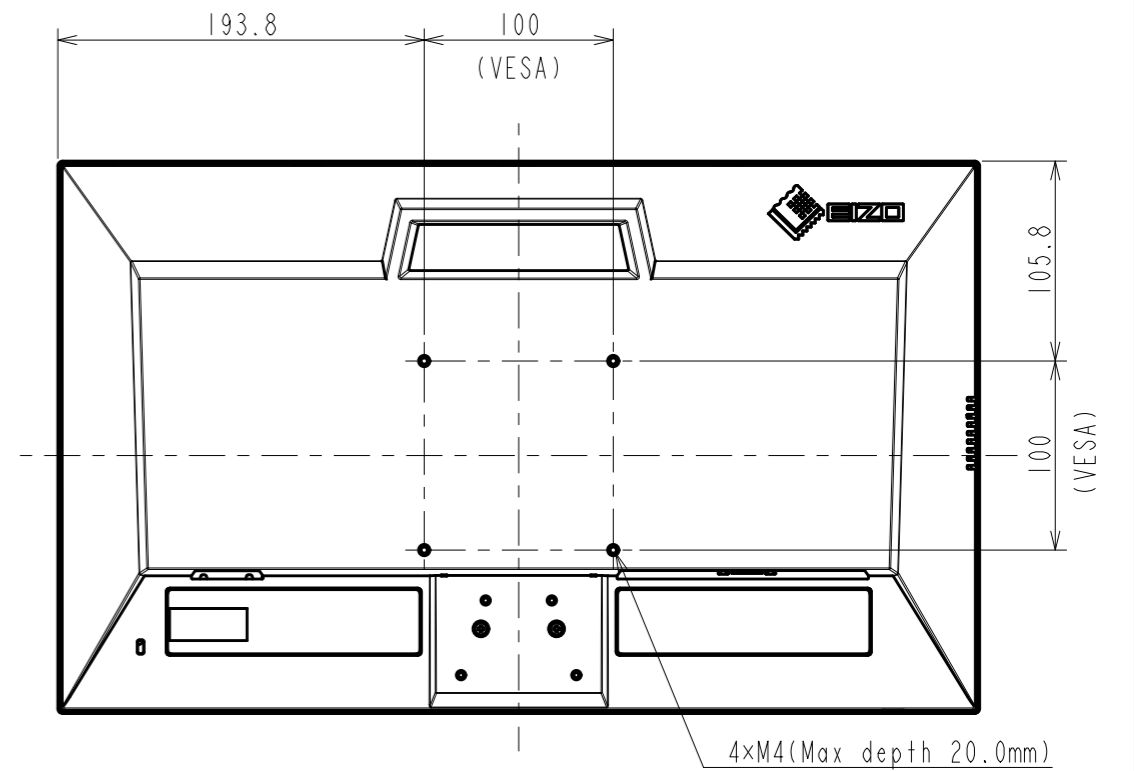
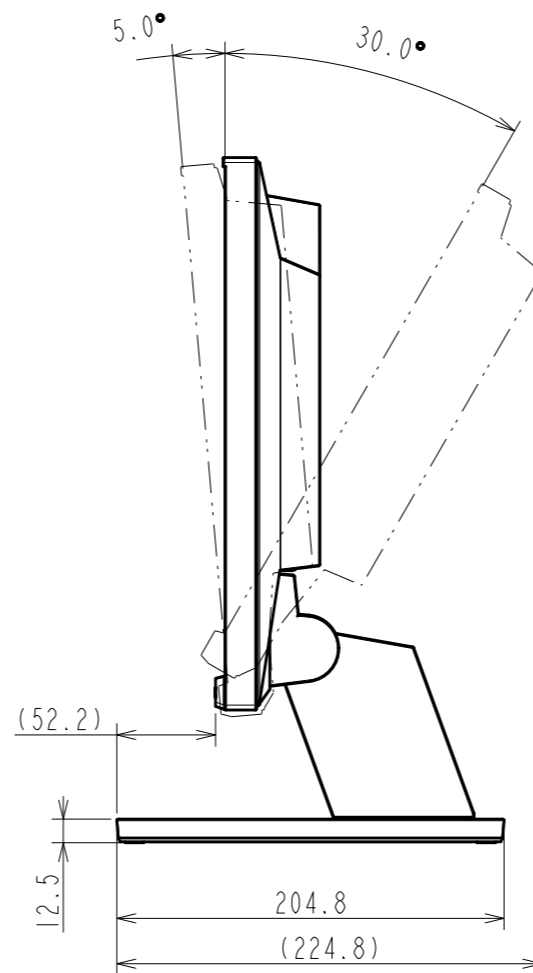
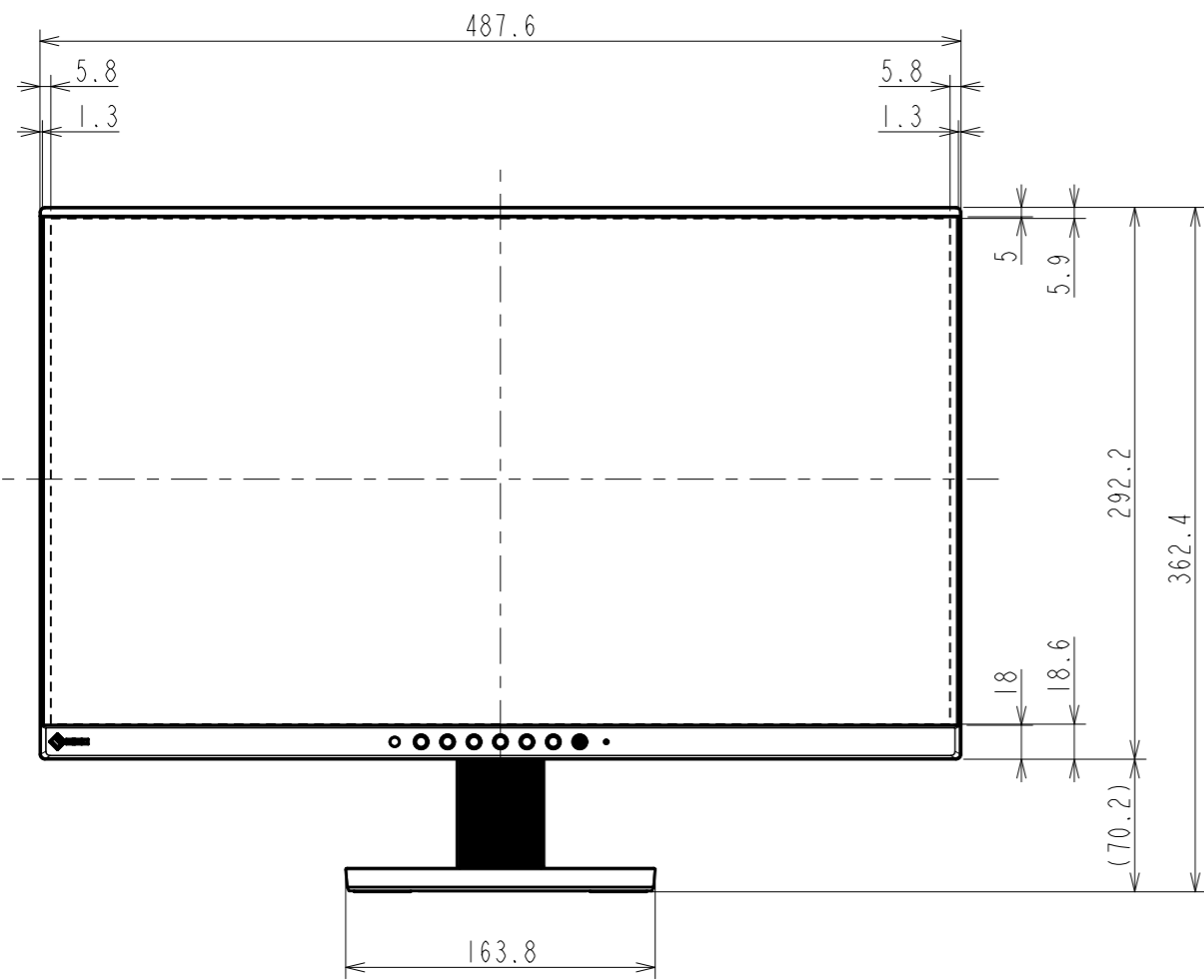
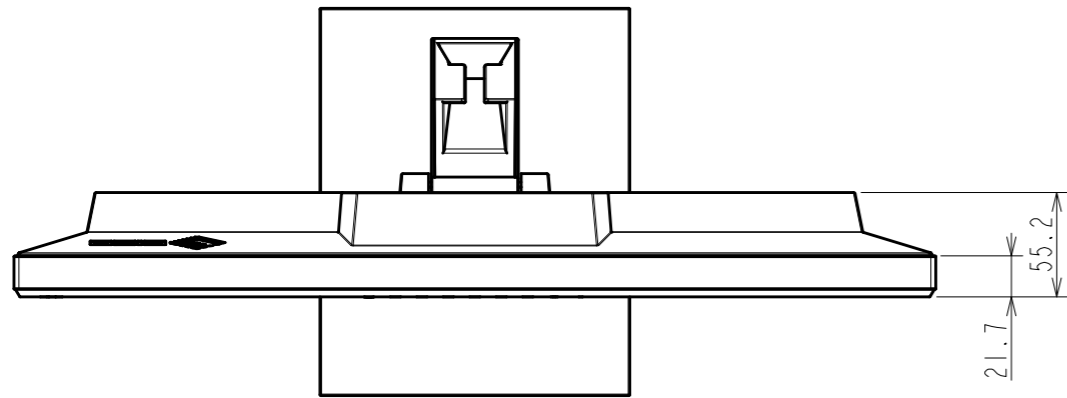

# OUTLINE DIMENSIONS

MODEL EV2130

UNIT mm

**EIZO Corporation**

